

ifm electronic

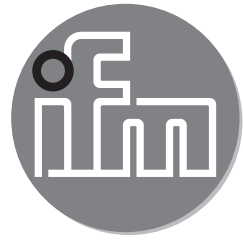

Operating instructions
Electronic pressure sensor

efector500[®]

PI28xx

UK

706162 / 00 02 / 2012

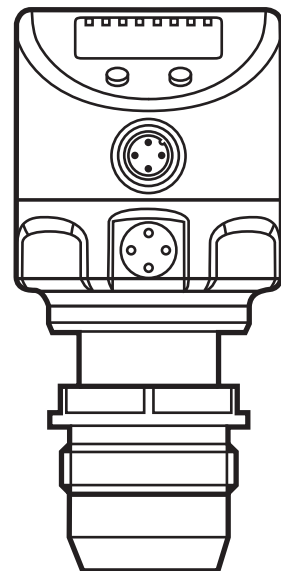

Contents

1	Preliminary note.....	4
1.1	Symbols used	4
2	Safety instructions	4
3	Functions and features	5
3.1	Applications	5
4	Function.....	5
4.1	Operating modes	6
4.1.1	2-wire operation.....	6
4.1.2	3-wire operation.....	6
4.2	Switching function (only for 3-wire operation).....	6
4.3	Analogue function	7
4.4	Customer-specific calibration	9
5	Installation.....	10
6	Electrical connection.....	11
6.1	Connection for 2-wire operation	11
6.2	Connection for IO-Link parameter setting.....	11
6.3	Connection for 3-wire operation	12
7	Operating and display elements	13
8	Menu.....	14
8.1	Menu structure: main menu	14
8.2	Explanation of the main menu	15
8.3	Menu structure: level 2 (extended functions).....	16
8.4	Explanation of the menu level 2	17
8.5	Menu structure: level 3 (simulation).....	18
8.6	Explanation of the menu level 3	19
9	Parameter setting	20
9.1	General parameter setting.....	20
9.2	Configure display (optional).....	22
9.3	Set output signals	23
9.3.1	Set output functions.....	23
9.3.2	Set switching limits	23
9.3.3	Scale analogue value for OUT2	23
9.4	User settings (optional).....	24
9.4.1	Carry out zero point calibration	24

9.4.2	Setting of the error behaviour of the outputs	25
9.4.3	Set delay for the switching outputs	25
9.4.4	Set switching logic for the switching outputs	25
9.4.5	Set damping for the switching signal	25
9.4.6	Set damping for the analogue signal	25
9.4.7	Calibrate curve of measured values	26
9.5	Service functions	26
9.5.1	Read min/max values for system pressure	26
9.5.2	Reset all parameters to factory setting	27
9.6	Simulation function	27
9.6.1	Open menu level 3 (simulation).....	27
9.6.2	Set simulation value	27
9.6.3	Set time for simulation	27
9.6.4	Start simulation.....	28
10	Operation.....	28
10.1	Read set parameters	28
10.2	Change the display in the Run mode	28
10.3	Self-diagnosis / error indications	28
11	Scale drawing	31
12	Technical data.....	32
12.1	Setting ranges	33
13	Factory setting	35

UK

1 Preliminary note

1.1 Symbols used

► Instructions

> Reaction, result

[...] Designation of pushbuttons, buttons or indications

→ Cross-reference



Important note

Non-compliance can result in malfunction or interference.



Information

Supplementary note.

2 Safety instructions

- Please read this document prior to set-up of the unit. Ensure that the product is suitable for your application without any restrictions.
- If the operating instructions or the technical data are not adhered to, personal injury and/or damage to property can occur.
- Check the compatibility of the product materials (→ chapter 12 Technical data) with the media to be measured in all applications.



The unit must only be installed in a process connection for G1 sealing cones (e.g. ifm welding adapter, order no. E30013).

If the unit is installed in a 1" thread without sealing cone, this will lead to seal failure. Please use the PI27xx series in these applications.

For the scope of validity cULus:

The device shall be supplied from an isolating transformer having a secondary Listed fuse rated either

a) max 5 amps for voltages 0~20 Vrms (0~28.3 Vp) or

b) 100/Vp for voltages of 20~30 Vrms (28.3~42.4 Vp).

The Sensor shall be connected only by using any R/C (CYJV2) cord, having suitable ratings.

3 Functions and features

The unit measures and monitors the system pressure in a plant.

3.1 Applications

Type of pressure: relative pressure

Order no.	Measuring range		Permissible overpressure		Bursting pressure	
	bar	PSI	bar	PSI	bar	PSI
PI2893	-1...25	-14.4...362.7	100	1450	350	5075
PI2894	-1...10	-14.5...145	50	725	150	2175
PI2895	-1...4	-14.5...58	30	435	100	1450
PI2896	-0.124...2.5	-1.8...36.27	20	290	50	725
PI2897	-0.05...1	-0.73...14.5	10	145	30	435
PI2899	-1...1	-14.5...14.5	10	145	30	435
	mbar	inH2O	bar	inH2O	bar	inH2O
PI2898	-12.4...250	-5.0..100.4	10	4015	30	12044
PI2889	-5...100	-2.00...40.16	4	1606	30	12044



Avoid static and dynamic overpressure exceeding the given overload pressure by taking appropriate measures.

The indicated bursting pressure must not be exceeded.

Even if the bursting pressure is exceeded only for a short time, the unit may be destroyed. ATTENTION: Risk of injury!

4 Function

- The unit displays the current system pressure.
- It generates output signals according to the operating mode and the parameter setting.
- It moreover provides the process data via IO-Link.
- The unit is laid out for fully bidirectional communication. So, the following options are possible:
 - Remote display: reading and display of the current system pressure.
 - Remote parameter setting: reading and changing the current parameter setting.
 - Using the FDT service program ifm Container, the current parameter settings can be stored and transferred to other units of the same type.

The program library of the available DTM objects can be found at www.ifm.com
→ Service → Download.

For IO-Link parameter setting → IO-Device Description (IODD) at: www.ifm.com

4.1 Operating modes

The operating mode is defined by the wiring (→ 6 Electrical connection) and automatically recognised.

4.1.1 2-wire operation

OUT2 (pin 2)	analogue signal proportional to pressure 4...20 mA or 20...4 mA
---------------------	---

4.1.2 3-wire operation

OUT1 (pin 4)	<ul style="list-style-type: none">• switching signal for system pressure limit value• communication via IO-Link
OUT2 (pin 2)	3 options: <ul style="list-style-type: none">• switching signal for system pressure limit value• analogue signal proportional to pressure 4...20 mA• analogue signal proportional to pressure 20...4 mA

4.2 Switching function (only for 3-wire operation)

OUT_x changes its switching state if it is above or below the set switching limits (SP_x, rP_x). The following switching functions can be selected:

- Hysteresis function / normally open: [OU_x] = [Hno] (→ fig. 1).
- Hysteresis function / normally closed: [OU_x] = [Hnc] (→ fig. 1).

First the set point (SP_x) is set, then the reset point (rP_x) with the requested difference.

- Window function / normally open: [OU_x] = [Fno] (→ fig. 2).
- Window function / normally closed: [OU_x] = [Fnc] (→ fig. 2).

The width of the window can be set by means of the difference between SP_x and rP_x. SP_x = upper value, rP_x = lower value.

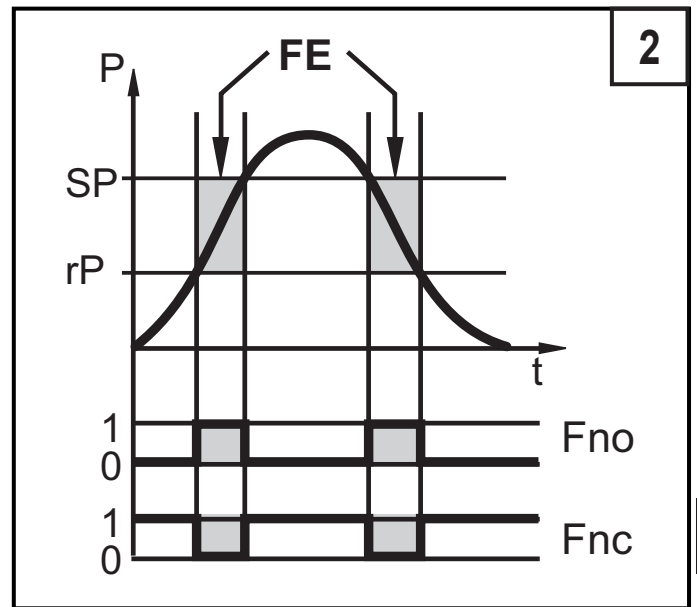
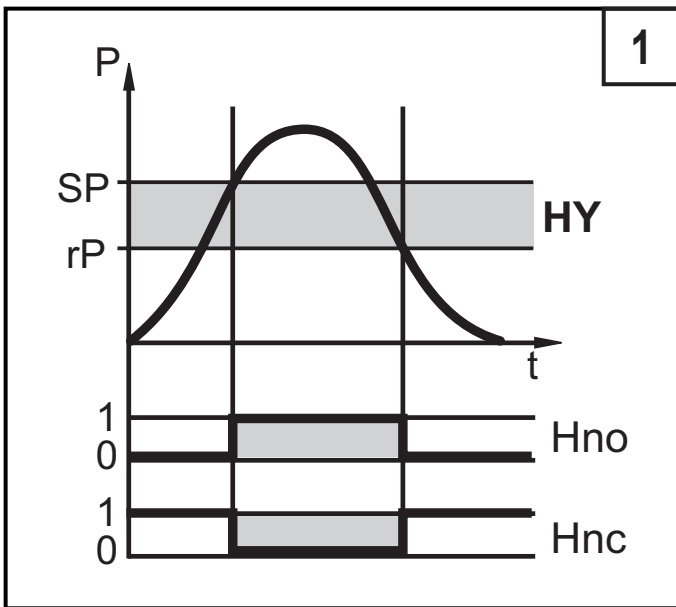

P = system pressure; HY = hysteresis; FE = window

4.3 Analogue function

The analogue output can be configured.

- [OU2] defines whether the set measuring range is provided as 4...20 mA ([OU2] = [I]) or as 20...4 mA ([OU2] = [InEG]).

Scaling can be set by means of the teaching process or by entering a value for the ASP and AEP parameters.

- Teaching the analogue start point [tASP] or setting the parameter [ASP] defines at which measured value the analogue signal is 4 mA (20 mA at [InEG]).
- Teaching the analogue end point [tAEP] or setting the parameter [AEP] defines at which measured value the output signal is 20 mA (4 mA at [InEG]).

UK

Minimum distance between [ASP] and [AEP] = 25 % of the final value of the measuring range (turn-down 1:4); for PI2899: 25 % of the measuring span.

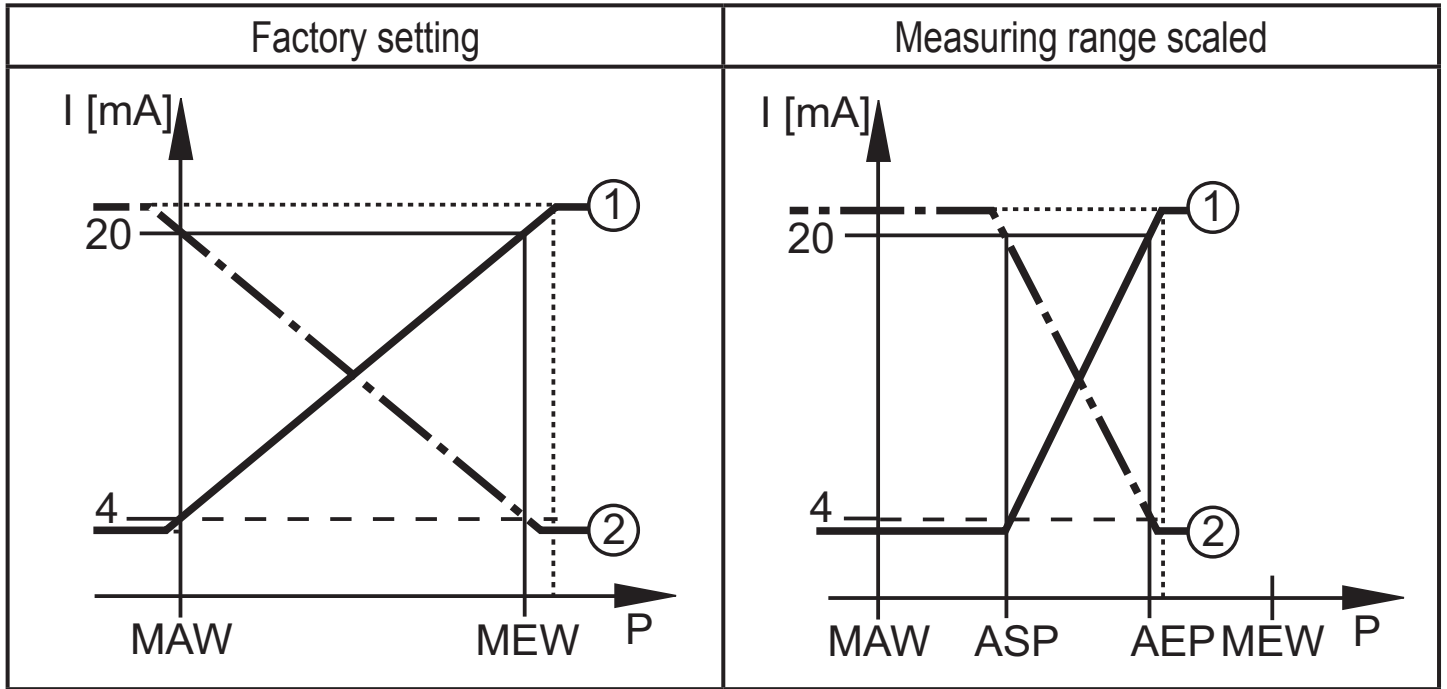

P = system pressure , MAW = initial value of the measuring range, MEW = final value of the measuring range

①: [OU2] = [I]; ②: [OU2] = [InEG]

In the set measuring range the output signal is between 4 and 20 mA ([OU2] = [I]) or between 20 and 4 mA ([OU2] = [InEG]).

It is also indicated:

- System pressure above the measuring range:
 - Output signal > 20 mA at [OU2] = [I].
 - Output signal 4 to 3.8 mA at [OU2] = [InEG].
- System pressure below the measuring range:
 - Output signal 4 to 3.8 mA at [OU2] = [I].
 - Output signal > 20 mA at [OU2] = [InEG].

4.4 Customer-specific calibration

The customer-specific calibration changes the curve of measured values compared to the real measured values (shifting / change of the gradient; → 9.4.6 [CAL]).

- Two calibration points can be defined (CP1, CP2). The two points are independent of each other.
- The two calibration points must be within the scaled measuring range (→ 4.3 Pressure monitoring / analogue function).
- The zero point calibration [COF] influences the calibration of the curve of measured values. Recommendation: set [COF] to 0 (→ 9.4.1 [COF]), then calibrate the curve of measured values.

UK

After a change the calibration can be reset to factory setting (→ 9.5.2 [rES]).

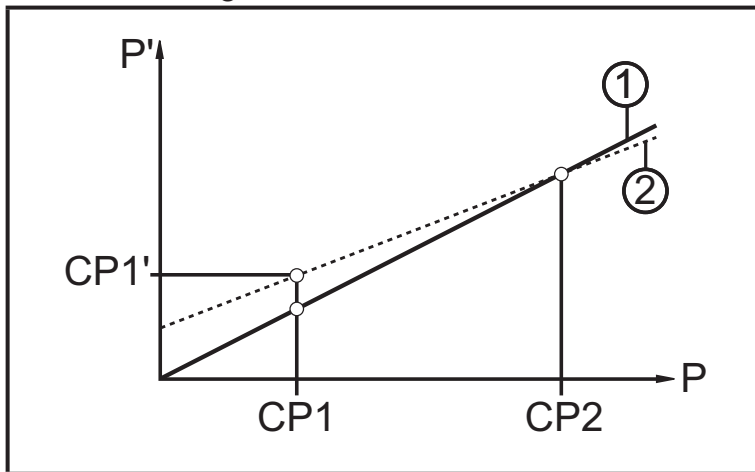

- P = measured pressure;
- P' = modified measured value
- CP1 = calibration point 1;
- CP1' = modified measured value for CP1
- CP2 = calibration point 2;
- 1 = curve of measured values at factory setting
- 2 = curve of measured values after calibration

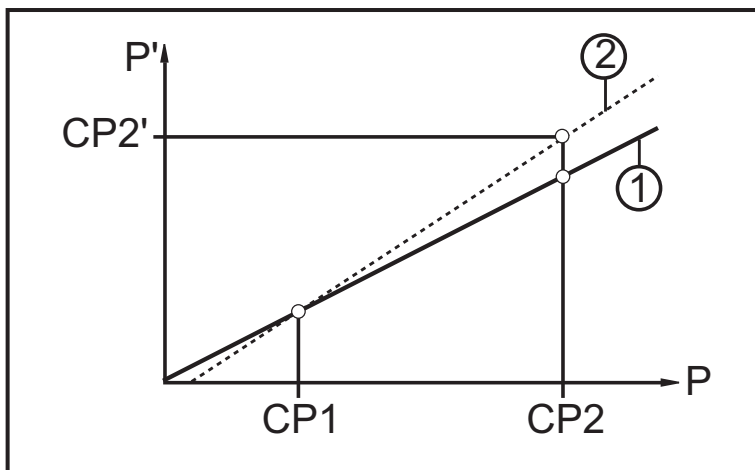

- P = measured pressure;
- P' = modified measured value
- CP1 = calibration point 1;
- CP2 = calibration point 2;
- CP2' = modified measured value for CP2
- 1 = curve of measured values at factory setting
- 2 = curve of measured values after calibration

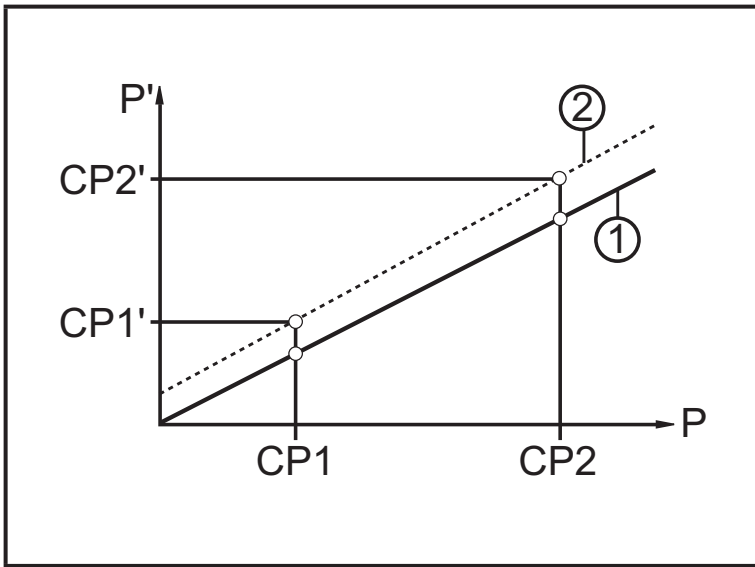

- P = measured pressure;
- P' = modified measured value
- CP1 = calibration point 1;
- CP1' = modified measured value for CP1
- CP2 = calibration point 2;
- CP2' = modified measured value for CP2
- 1 = curve of measured values at factory setting
- 2 = curve of measured values after calibration

5 Installation



Before installing and removing the unit: make sure that no pressure is applied to the system. Please consider when the system pressure is displayed in % of the span: "0" does not mean that no pressure is applied to the system!



The unit must only be installed in a process connection for G1 sealing cones (e.g. ifm welding adapter, order no. E30013).

If the unit is installed in a 1" thread without sealing cone, this will lead to seal failure. Please use the PI27xx series in these applications.

Installation in a process connection for a G1 sealing cones

- ▶ Slightly grease the thread of the threaded sleeve (B) using a lubricating paste which is suitable and approved for the application.
- ▶ Insert the unit (A) into the process connection (C), push the threaded sleeve towards the internal thread of the process connection and lightly screw it in.
- ▶ Orientate the unit, tighten the threaded sleeve with a spanner and ensure that the unit is correctly oriented while doing so. Tightening torque 20 Nm.

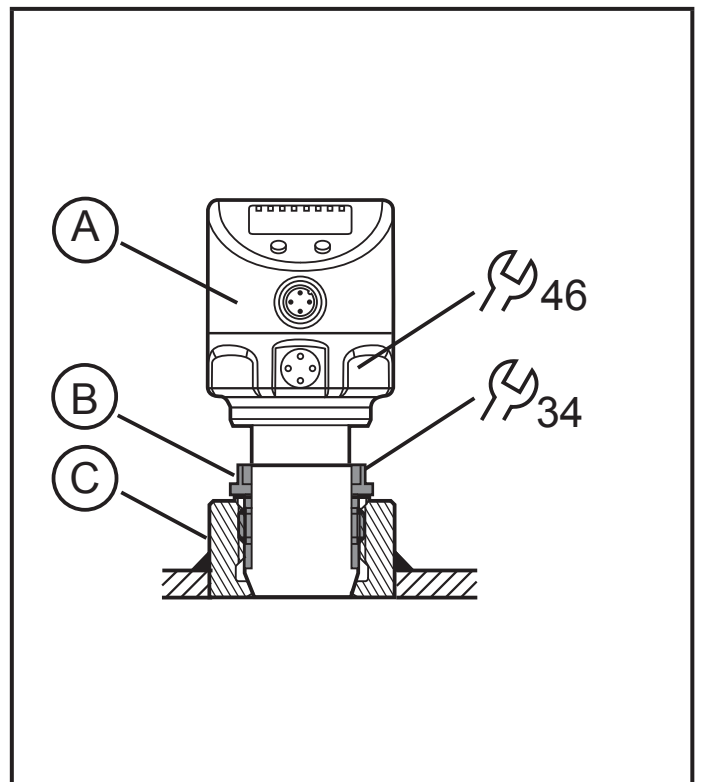

Use in hygienic areas to EHEDG

- ▶ Make sure that the sensors are integrated into the system in accordance with EHEDG.

6 Electrical connection



The unit must be connected by a qualified electrician.

The national and international regulations for the installation of electrical equipment must be adhered to.

Voltage supply according to EN 50178, SELV, PELV.

- ▶ Disconnect power.
- ▶ Connect the unit as follows:

6.1 Connection for 2-wire operation

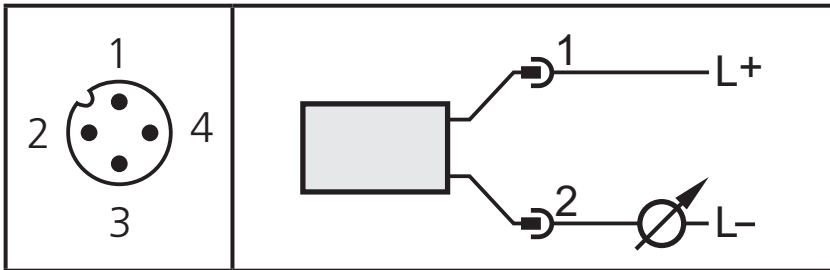

6.2 Connection for IO-Link parameter setting

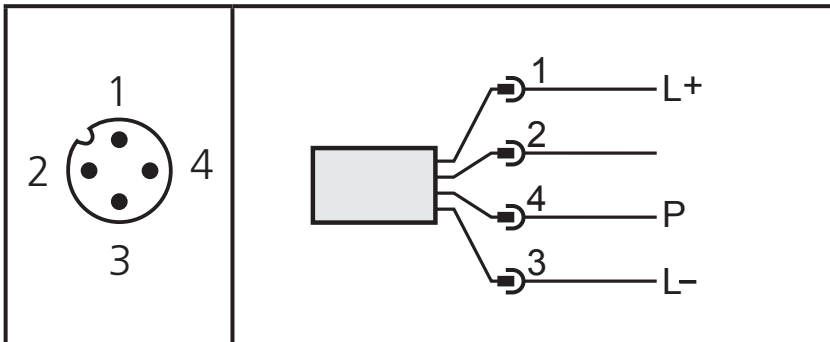

Pin 1	Ub+
Pin 2	Output function according to the OU2 setting
Pin 3	Ub- for programming mode
Pin 4 (P)	Communication via IO-Link

6.3 Connection for 3-wire operation

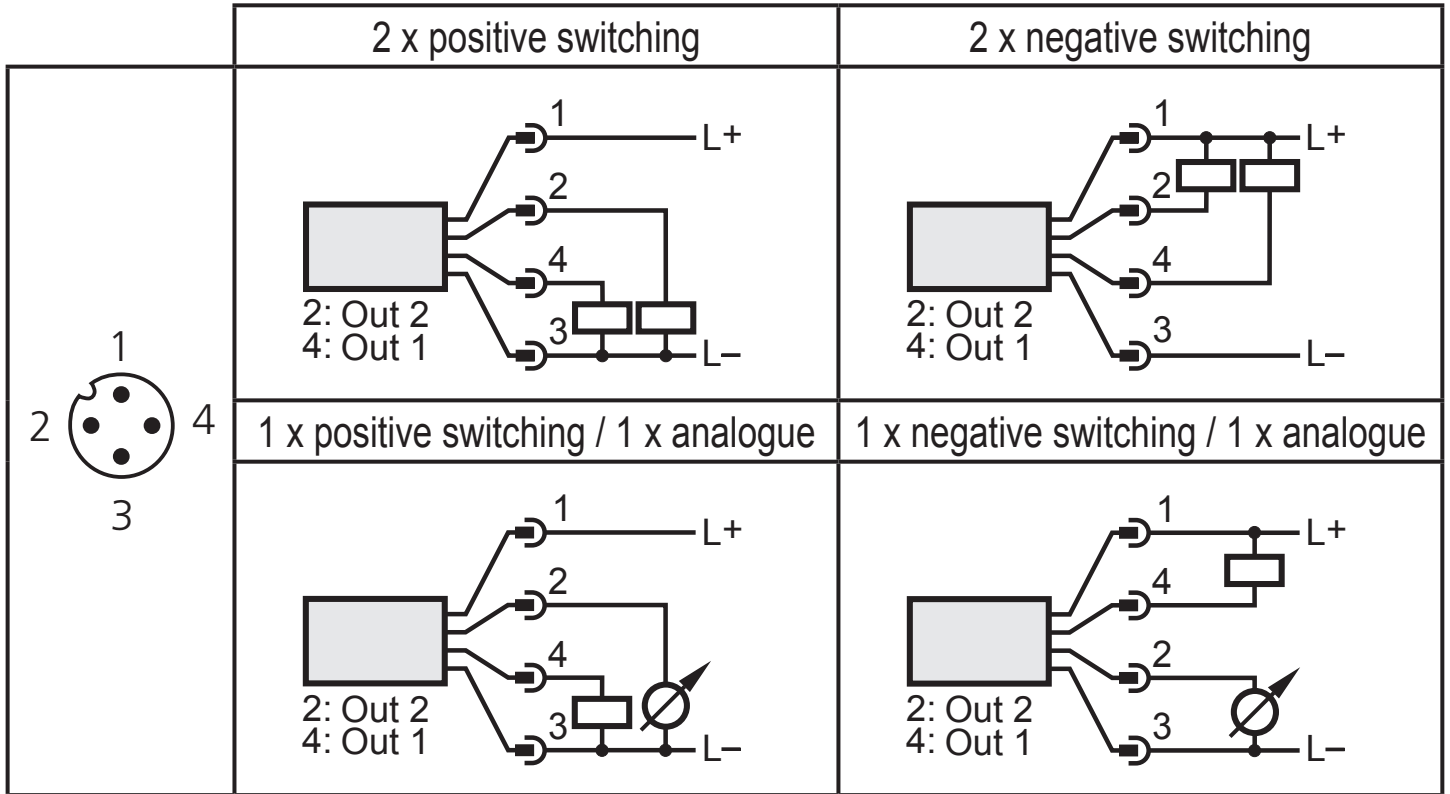

Pin 1	Ub+
Pin 3	Ub-
Pin 4 (OUT1)	<ul style="list-style-type: none"> • Binary switching output pressure monitoring • Communication via IO-Link
Pin 2 (OUT2)	Binary switching output pressure monitoring or analogue output for system pressure.

7 Operating and display elements

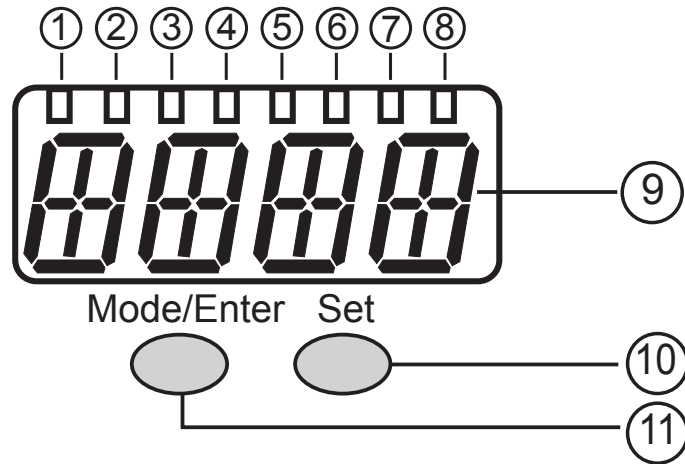

1 to 8: Indicator LEDs

- LED 1 to LED 5 = system pressure in the specified unit of measurement.
- LED 6 = System pressure in % of the set scaling of the analogue output if [OU2] is configured as analogue output.
System pressure in % of the final value of the measuring range if [OU2] is configured as switching output.
- LED 7 = switching status OUT2 (lights if output 2 is switched).
- LED 8 = switching status OUT1 (lights if output 1 is switched)

9: Alphanumeric display, 4 digits

- Display of the current system pressure.
- Indication of the parameters and parameter values.

10: Set pushbutton

- Setting of the parameter values (scrolling by holding pressed; incrementally by pressing once).

11: Mode/Enter button

- Selection of the parameters and acknowledgement of the parameter values.

8 Menu

8.1 Menu structure: main menu

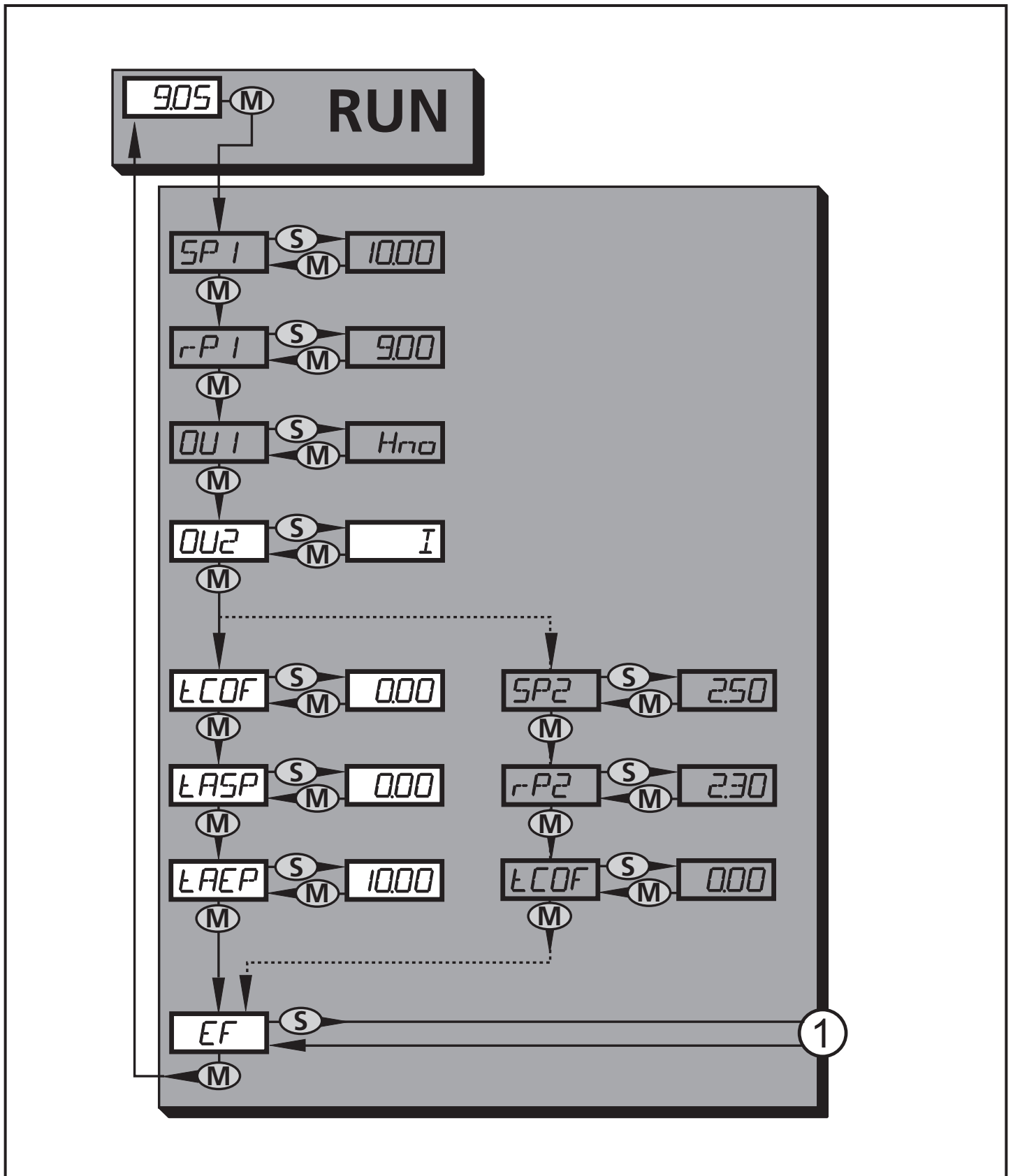

1: Change to menu level 2 (extended functions)

Menu items highlighted grey (SP1) are not active in 2-wire operation.

8.2 Explanation of the main menu

SP1/rP1*	Upper / lower limit value for system pressure at which OUT1 switches.
OU1*	Output function for OUT1: <ul style="list-style-type: none"> • Switching signal for the pressure limit values: hysteresis function [H ..] or window function [F ..], either normally open [. no] or normally closed [. nc].
OU2	Output function for OUT2: <ul style="list-style-type: none"> • Switching signal for the pressure limit values: hysteresis function [H ..] or window function [F ..], either normally open [. no] or normally closed [. nc]; (only available for 3-wire operation). • Analogue signal for the current system pressure: 4...20 mA [I], 20...4 mA [InEG].
tCOF	Teach zero-point calibration.
tASP	Teach analogue start point for system pressure: set measured value at which 4 mA is provided (20 mA if [OU2] = [InEG]).
tAEP	Teach analogue end point for system pressure: set measured value at which 20 mA is provided (4 mA if [OU2] = [InEG]).
SP2/rP2*	Upper / lower limit value for system pressure at which OUT2 switches.
EF	Extended functions / opening of menu level 2.

* menu items not active in 2-wire operation

UK

8.3 Menu structure: level 2 (extended functions)

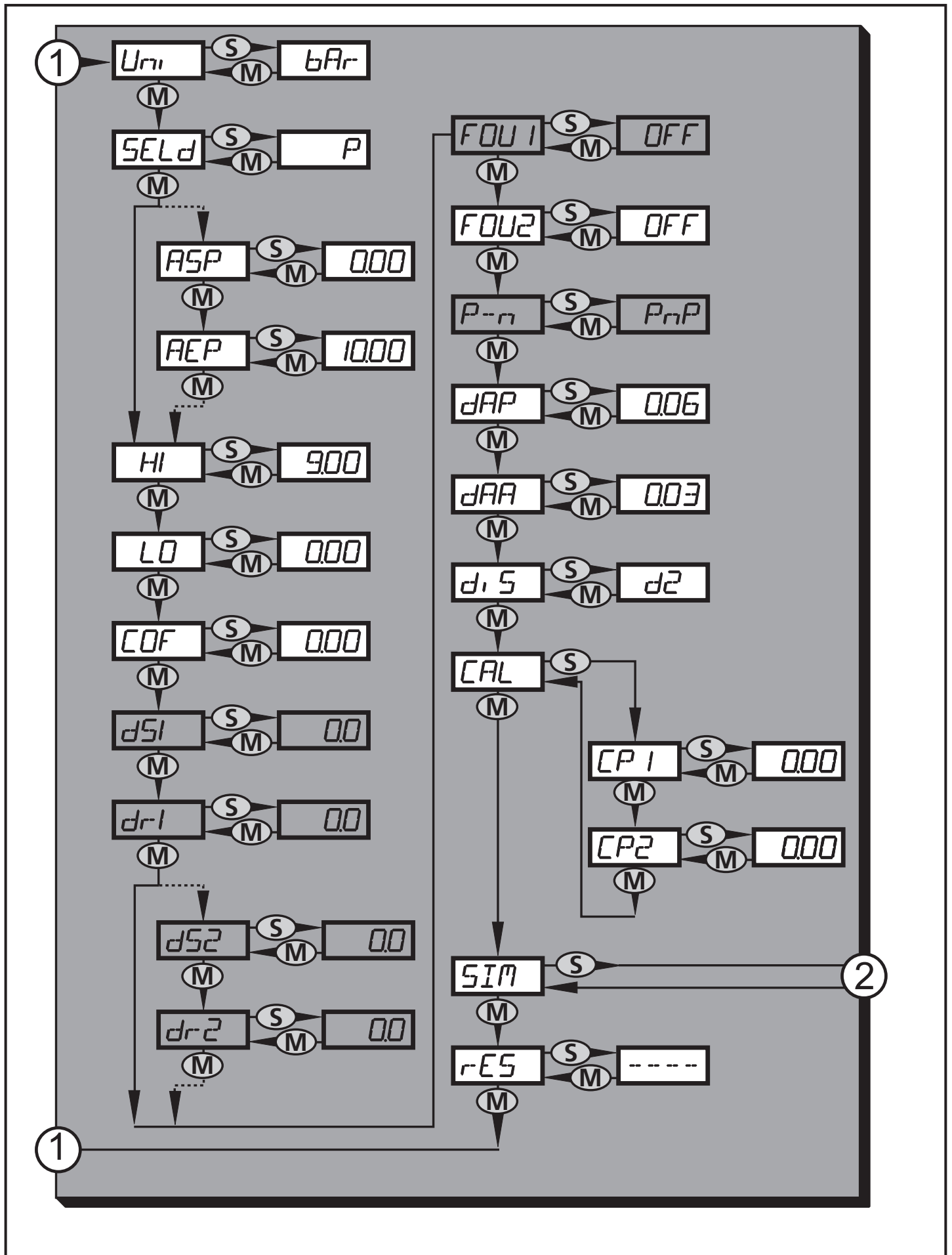

1: Change to the main menu; 2: Change to menu level 3 (simulation)
 Menu items highlighted grey (ASP) are not active in 2-wire operation.

8.4 Explanation of the menu level 2

Uni	Standard unit of measurement for system pressure.
SELd	Display mode: <ul style="list-style-type: none"> • Pressure in the unit set in [Uni]. • System pressure in % of the set scaling of the analogue output if [OU2] is configured as analogue output. • System pressure in % of the final value of the measuring range if [OU2] is configured as switching output.
ASP	Analogue start point for system pressure: measured value at which 4 mA is provided (20 mA if [OU2] = [InEG]).
AEP	Analogue end point for system pressure: measured value at which 20 mA is provided (4 mA if [OU2] = [InEG]).
HI	Maximum value memory for system pressure.
LO	Minimum value memory for system pressure.
COF	Zero-point calibration.
dS1*	Switch-on delay for OUT1.
dr1*	Switch-off delay for OUT1.
dS2*	Switch-on delay for OUT2; only active if [OU2] = [Hnc], [Hno], [Fnc] or [Fno].
dr2*	Switch-off delay for OUT2; only active if [OU2] = [Hnc], [Hno], [Fnc] or [Fno].
FOU1*	Behaviour of output 1 in case of an internal fault.
FOU2	Behaviour of output 2 in case of an internal fault.
P-n*	Switching logic for the outputs: pnp or npn.
dAP	Damping for switching outputs and display.
dAA	Damping for analogue output (OUT2); also has effect on the IO-Link process value.
diS	Update rate and orientation of the display.
CAL	Calibration function (setting the curve of measured values).
CP1	Calibration point 1
CP2	Calibration point 2
SIM	Change to menu level 3 (simulation)
rES	Restore factory settings.

* menu items not active in 2-wire operation

8.5 Menu structure: level 3 (simulation)

For setting SEL = OU

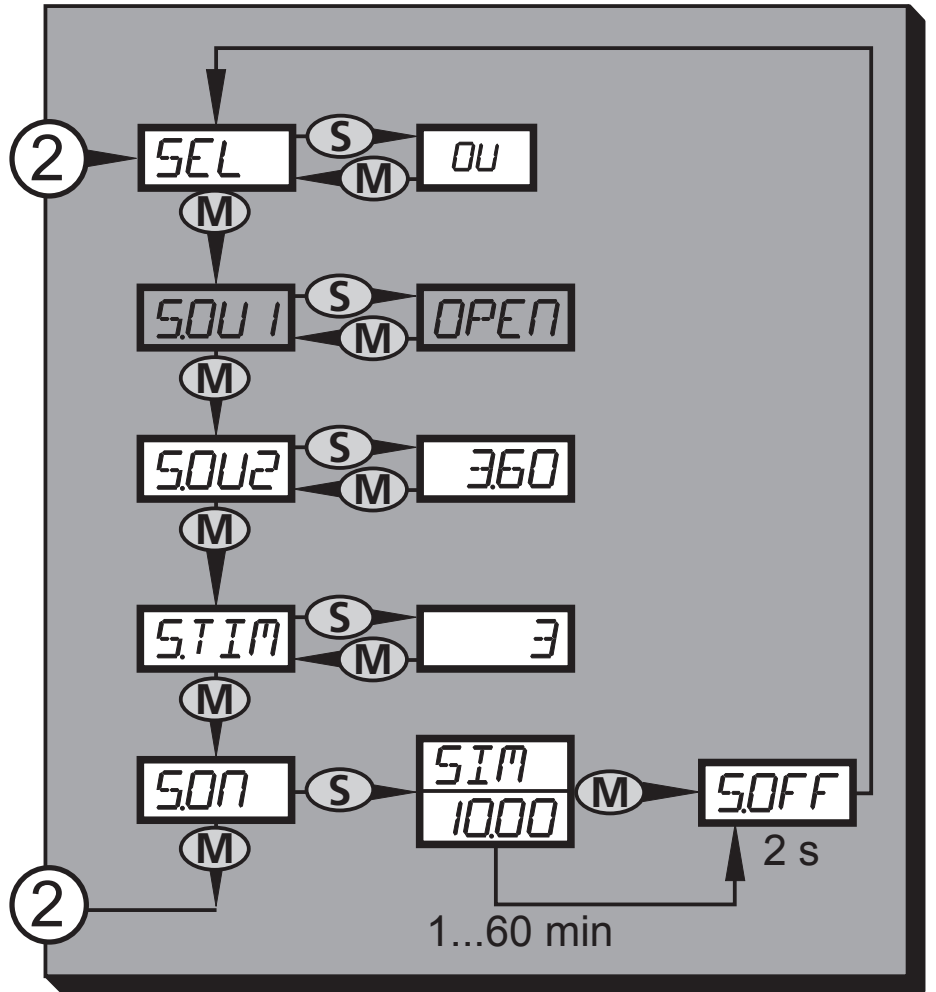

For setting SEL = Proc

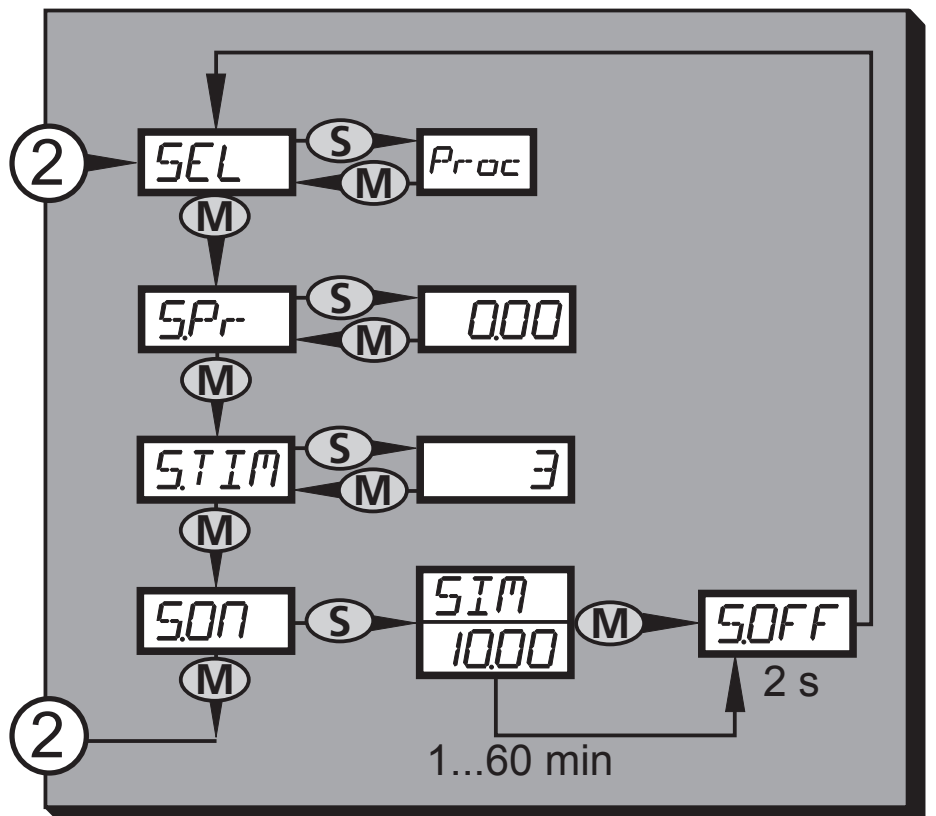

2: Change to menu level 2 (extended functions)

Menu items highlighted grey (S.OU1) are not active in 2-wire operation.

8.6 Explanation of the menu level 3

For setting SEL = OU	
SEL	Status to be simulated: • Output functions [OU].
S.OU1*	Simulation values for OUT1; only active for 3-wire operation and if [SEL] = [OU]. • Output inactive [OPEN] or output active [CLOS].
S.OU2	Simulation values for OUT2; only active if [SEL] = [OU]. • For 3-wire operation and if OUT2 has been configured as switching output: output inactive [OPEN] or active [CLOS]. • If OUT2 is set as analogue output: analogue signal between 3.6 and 21.1 mA (depending on the set value → 9.6.2).
S.TIM	Time for the simulation process in minutes.
S.ON	Start of the simulation process. During the simulation process the display alternately shows [SIM] and the current operation indication (9.6.4)→. If the simulation process is aborted (press [Mode/Enter] or [Set] briefly), [S.OFF] is indicated for 2 s, then [SEL] is active again.

* menu item not active in 2-wire operation

For setting SEL = Proc	
SEL	Status to be simulated: • Process value [Proc].
S.Pr	Simulation of a process value; only active if [SEL] = [Proc]. • Any value between initial value of the measuring range and final value of the measuring range.
S.TIM	Time for the simulation process in minutes.
S.ON	Start of the simulation process. During the simulation process the display alternately shows [SIM] and the current operation indication (→ 9.6.4). If the simulation process is aborted (press [Mode/Enter] or [Set] briefly) [S.OFF] is indicated for 2 s, then [SEL] is active again.

UK

9 Parameter setting

During parameter setting the unit remains in the operating mode. It continues its monitoring function with the existing parameters until the parameter setting has been completed.

Exceptions: changes to the parameters COF (→ 9.4.1), CP1 and CP2 (→ 9.4.7) take effect immediately.

9.1 General parameter setting

3 steps must be taken for each parameter setting:

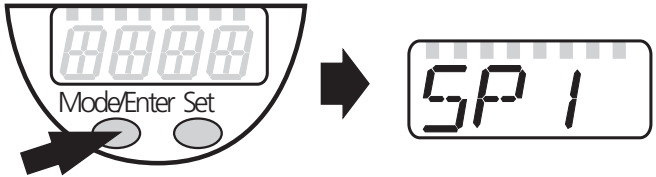
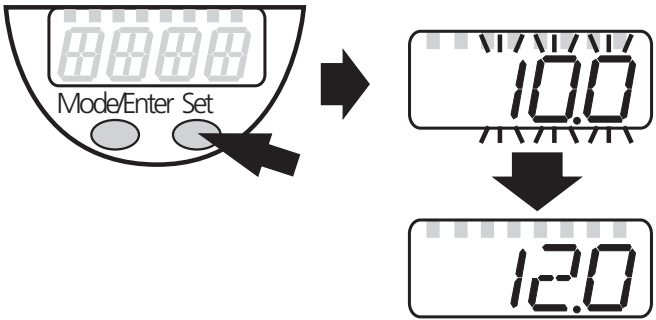
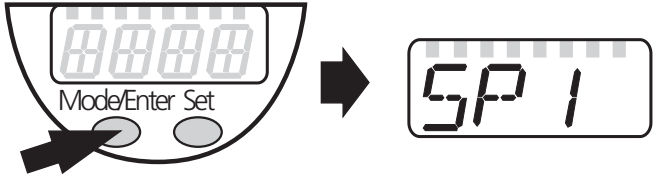
<p>1 Select parameter</p> <ul style="list-style-type: none"> ▶ Press [Mode/Enter] until the requested parameter is displayed. <p>If the main menu is protected by an access code, [Cod0] flashes in the display.</p> <ul style="list-style-type: none"> ▶ Press [Set] and keep it pressed until the valid code no. is displayed. ▶ Press [Mode/Enter] briefly. <p>On delivery by ifm electronic: no access restriction.</p>	 <p>The diagram shows a control panel with a four-digit display. An arrow points to the 'Mode/Enter' button. A second arrow points to the 'Set' button. The final display shows 'SP 1'.</p>
<p>2 Set parameter value</p> <ul style="list-style-type: none"> ▶ Press [Set] and keep it pressed. > Current setting value of the parameter flashes for 5 s. > After 5 s: setting value is changed: incrementally by pressing the button once or continuously by keeping the button pressed. 	 <p>The diagram shows the control panel with the 'Set' button being pressed. The display shows '10.0' with a flashing effect. A downward arrow indicates the value changing to '12.0'.</p>
<p>Numerical values are incremented continuously. For reducing the value: let the display move to the maximum setting value. Then the cycle starts again at the minimum setting value.</p>	
<p>3 Acknowledge parameter value</p> <ul style="list-style-type: none"> ▶ Press [Mode/Enter] briefly > The parameter is displayed again. The new setting value is stored. 	 <p>The diagram shows the control panel with the 'Mode/Enter' button being pressed. The final display shows 'SP 1'.</p>
<p>Set other parameters</p> <ul style="list-style-type: none"> ▶ Start again with step 1. 	
<p>Finish parameter setting</p> <ul style="list-style-type: none"> ▶ Press [Mode/Enter] several times until the current measured value is displayed or wait for 15 s. > The unit returns to the operating mode. 	



For 2-wire operation those menu items referring to switching functions are not active (→ 8 Menu structure); for some menu items those parameter values referring to switching functions cannot be selected.

- If [SLoc] is displayed when attempting a modification of a parameter value, the sensor is locked via software. This locking can only be removed via a parameter setting software.
- When parameter setting with the user interface of the ifm Container program, the values can be directly entered in the specified fields.
- For IO-Link parameter setting → IO-Device Description (IODD) at: www.ifm.com
- Change from menu level 1 to menu level 2:

UK

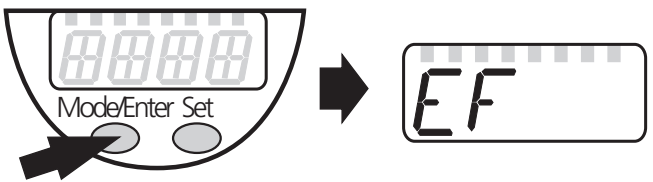
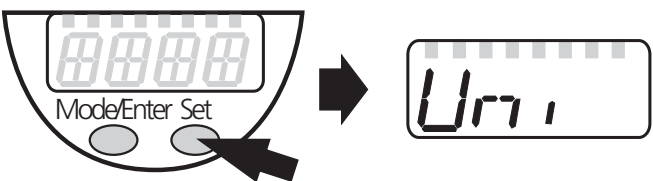
<p>▶ Press [Mode/Enter] until [EF] is displayed.</p>	
<p>▶ Press [Set] briefly > The first parameter of the submenu is displayed (here: [Uni]). If the menu level 2 is protected by an access code, "Cod1" flashes in the display.</p> <p>▶ Press [Set] and keep it pressed until the valid code no. is displayed. ▶ Press [Mode/Enter] briefly. On delivery by ifm electronic: no access restriction.</p>	

- Locking / unlocking

The unit can be locked electronically to prevent unintentional settings.

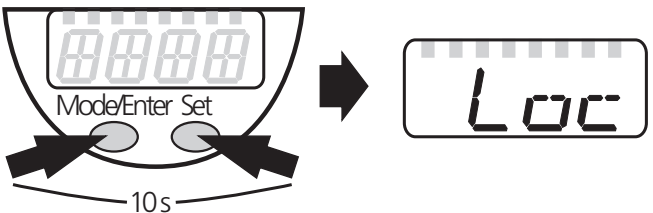
<p>▶ Make sure that the unit is in the normal operating mode. ▶ Press [Mode/Enter] + [Set] for 10 s. > [Loc] is displayed.</p>	
<p>During operation: [Loc] is briefly displayed if you try to change parameter values.</p>	

For unlocking:
 ▶ Press [Mode/Enter] + [Set] for 10 s.
 > [uLoc] is displayed.

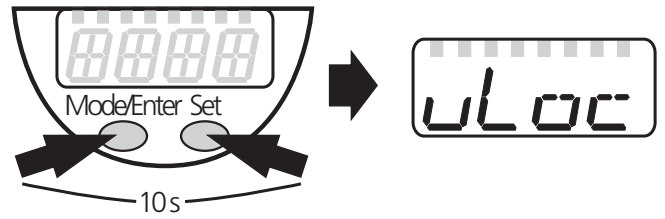

On delivery: unlocked.

• Timeout:

If no button is pressed for 15 s during parameter setting, the unit returns to the operating mode with unchanged values.

9.2 Configure display (optional)

<p>▶ Select [Uni] and set the unit of measurement:</p> <ul style="list-style-type: none"> - [bAr], [mbAr]. - [MPa], [kPa]. - [PSI] (only PI2893, PI2894, PI2895, PI2896, PI2897, PI2899). - [InHO] (only PI2889, PI2896, PI2897, PI2898, PI2899). - [mWS] (only PI2896, PI2897, PI2899). - [mmWS] (only PI2889 and PI2898). 	
<p>▶ Select [SELD] and set type of indication:</p> <ul style="list-style-type: none"> - [P]: system pressure in the unit set in Uni. - [P%]: system pressure in % of the set scaling of the analogue output; the following applies: 0% = ASP value / 100% = AEP value. If OU2 has been configured as switching output, [ASP] and [AEP] are not active. In this case the following applies: 0% = initial value of the measuring range/ 100% = final value of the measuring range. <p>If [SELD] = [P%] please take the following into account: "0" does not mean that no pressure is applied to the system!</p>	
<p>▶ Select [diS] and set the update rate and orientation of the display:</p> <ul style="list-style-type: none"> - [d1]: update of the measured values every 50 ms. - [d2]: update of the measured values every 200 ms. - [d3]: update of the measured values every 600 ms. - [rd1], [rd2], [rd3]: display as for d1, d2, d3; rotated by 180° - [OFF] = The measured value display is deactivated in the Run mode. Touching one of the buttons indicates the current measured value for 15 s. Pressing the [Mode/Enter] button again activates the display mode. The LEDs remain active even if the display is deactivated. Error messages are displayed even if the display is deactivated. 	

9.3 Set output signals

9.3.1 Set output functions

<ul style="list-style-type: none">▶ Select [OU1] and set the switching function:<ul style="list-style-type: none">- [Hno] = hysteresis function/NO,- [Hnc] = hysteresis function/NC,- [Fno] = window function/NO,- [Fnc] = window function/NC.	<i>OU 1</i>
<ul style="list-style-type: none">▶ Select [OU2] and set the function:<ul style="list-style-type: none">- [Hno] = hysteresis function/NO,- [Hnc] = hysteresis function/NC,- [Fno] = window function/NO,- [Fnc] = window function/NC.- [I] = current signal proportional to pressure 4...20 mA.- [InEG] = current signal proportional to pressure 20...4 mA.	<i>OU 2</i>



UK

9.3.2 Set switching limits

<ul style="list-style-type: none">▶ Select [SP1] / [SP2] and set the value at which the output switches.	<i>SP 1</i> <i>SP 2</i>
<ul style="list-style-type: none">▶ Select [rP1] / [rP2] and set the value at which the output switches back. rPx is always smaller than SPx. The unit only accepts values which are lower than the value for SPx.	<i>r-P 1</i> <i>r-P 2</i>



9.3.3 Scale analogue value for OUT2

<ul style="list-style-type: none">▶ Set the minimum pressure requested in the system.▶ Press [Mode/Enter] until [tASP] appears.▶ Press [Set] and keep it pressed.<ul style="list-style-type: none">> Current setting value flashes.▶ Release [Set] when the display stops flashing.<ul style="list-style-type: none">> New setting value is displayed.▶ Press [Mode/Enter] briefly.<ul style="list-style-type: none">> The current system pressure is defined as start value for the analogue signal.	<i>tASP</i>
--	-------------

<ul style="list-style-type: none"> ▶ Set the maximum pressure requested in the system. ▶ Press [Mode/Enter] until [tASP] appears. ▶ Press [Set] and keep it pressed. > Current setting value flashes. ▶ Release [Set] when the display stops flashing. > New setting value is displayed. ▶ Press [Mode/Enter] briefly. > The current system pressure is defined as end value for the analogue signal. 	
<p>ASP / AEP can only be set automatically within defined limits (→ 12.1 Setting ranges). If automatic setting is carried out at an invalid pressure value, [UL] or [OL] is displayed. After acknowledgement by [Mode/Enter] [Err] flashes, the ASP value / AEP value is not changed.</p>	
<p>As an alternative:</p> <ul style="list-style-type: none"> ▶ Select [ASP] and set the measured value at which 4 mA is provided (20 mA at [OU2] = [InEG]). ▶ Select [AEP] and set the measured value at which 20 mA is provided (4 mA at [OU2] = [InEG]). <p>Minimum distance between ASP and AEP = 25 % of the final value of the measuring range (turn-down 1:4).</p>	

9.4 User settings (optional)

9.4.1 Carry out zero point calibration

<ul style="list-style-type: none"> ▶ Select [COF] and set a value between -5% and 5% of the final value of the measuring range. The internal measured value "0" is shifted by this value. 	
<p>As an alternative: automatic adjustment of the offset in the range 0 bar ± 5%.</p> <ul style="list-style-type: none"> ▶ Make sure that no pressure is applied to the system. ▶ Press [Mode/Enter] until [tCOF] appears. ▶ Press [Set] and keep it pressed. > The current offset value (in %) flashes briefly. > The current system pressure is displayed. ▶ Release [SET]. ▶ Press [Mode/Enter] briefly (= to confirm the new offset value). 	

9.4.2 Setting of the error behaviour of the outputs

<ul style="list-style-type: none"> ▶ Select [FOU1] and set the value: <ul style="list-style-type: none"> - [On] = output 1 switches ON in case of a fault. - [OFF] = output 1 switches OFF in case of a fault. - [OU] = output 1 switches irrespective of the error as defined with the parameters SP1, rP1 and OU1. ▶ Select [FOU2] and set the value: <ul style="list-style-type: none"> - [On] = output 2 switches ON in case of a fault, the analogue signal goes to the upper end stop value. - [OFF] = output 2 switches OFF in case of a fault, the analogue signal goes to the lower end stop value. - [OU] = Output 2 switches irrespective of the error as defined with the parameters SP2, rP2 and OU2. The analogue signal corresponds to the measured value. 	
---	---

UK

Error indications → 10.3

9.4.3 Set delay for the switching outputs

<p>[dS1] / [dS2] = switch-on delay for OUT1 / OUT2. [dr1] / [dr2] = switch-off delay for OUT1 / OUT2.</p> <ul style="list-style-type: none"> ▶ Select [dS1], [dS2], [dr1] or [dr2] and set a value between 0.1 and 50 s (at 0.0 the delay time is not active). 	
--	--

9.4.4 Set switching logic for the switching outputs

<ul style="list-style-type: none"> ▶ Select [P-n] and set [PnP] or [nPn]. 	
--	---



9.4.5 Set damping for the switching signal

<ul style="list-style-type: none"> ▶ Select [dAP] and set a value between 0.00 and 30.00 s; (at 0.00 [dAP] is not active). <p>dAP value = response time between pressure change and change of the switching status in seconds. [dAP] influences the switching frequency: $f_{\max} = 1 \div 2dAP$. [dAP] also has an effect on the display.</p>	
---	---

9.4.6 Set damping for the analogue signal

<ul style="list-style-type: none"> ▶ Select [dAA] and set a value between 0.00 and 99.99 s; (at 0.00 [dAA] is not active). <p>dAA value = response time between pressure change and change of the analogue signal in seconds.</p>	
--	---

9.4.7 Calibrate curve of measured values

<ul style="list-style-type: none">▶ Set a defined reference pressure between ASP and AEP in the system.▶ Select [CAL].▶ Press [Set] briefly.> [CP1] is displayed.▶ Press [Set] for 5 s.> The pressure measured by the unit is displayed.▶ Press [Set] until the set reference pressure is indicated (measured pressure = reference pressure) or the corresponding analogue signal is provided on OUT2. Maximum correction value = $\pm 2\%$ of the final value of the measuring range.▶ Press [Mode/Enter] briefly.> [CP1] is displayed.▶ Press [Mode/Enter] briefly.> [CP2] is displayed. <p>Continue with a) or b)</p>	
<p>a) Finish calibration:</p> <ul style="list-style-type: none">▶ Press [Mode/Enter] briefly.> [CAL] is displayed. <p>b) Change a 2nd point on the curve of measured values</p> <ul style="list-style-type: none">▶ Set a second defined reference pressure in the system. Minimum distance between the calibration points CP1 and CP2 = 5% of the final value of the measuring range.▶ Press [Set] for 5 s.> The pressure measured by the unit is displayed.▶ Press [Set] until the set reference pressure is indicated (measured pressure = reference pressure) or the corresponding analogue signal is provided on OUT2. Maximum correction value = $\pm 2\%$ of the final value of the measuring range.▶ Press [Mode/Enter] briefly.> [CP2] is displayed.▶ Press [Mode/Enter] briefly.> [CAL] is displayed, the process is finished.	

9.5 Service functions

9.5.1 Read min/max values for system pressure

<ul style="list-style-type: none">▶ Select [HI] or [LO] and press [Set] briefly. [HI] = maximum value, [LO] = minimum value. <p>Delete memory:</p> <ul style="list-style-type: none">▶ Select [HI] or [LO].▶ Press [Set] and keep it pressed until [----] is displayed.▶ Press [Mode/Enter] briefly.	
--	---

9.5.2 Reset all parameters to factory setting



<ul style="list-style-type: none"> ▶ Select [rES]. ▶ Press [Set] and keep it pressed until [----] is displayed. ▶ Press [Mode/Enter] briefly. <p>It is recommended to take down your own settings in the table before carrying out a reset (→13 Factory setting).</p>	
--	---

9.6 Simulation function

9.6.1 Open menu level 3 (simulation)

<ul style="list-style-type: none"> ▶ Select [EF] and press [Set] briefly (= to open menu level 2). ▶ Select [SIM] and press [Set] briefly (= to open menu level 3). > [SEL] is displayed. 	
---	---

9.6.2 Set simulation value

<p>Output states</p> <p>If [SEL] is active:</p> <ul style="list-style-type: none"> ▶ Press [Set] and keep it pressed until [OU] is displayed. ▶ Press [Mode/Enter] briefly. > [S.OU1] is displayed (in 2-wire operation [S.OU2] is displayed). ▶ Press [Set] to set the requested value: <ul style="list-style-type: none"> - [OPEN] = output 1 not active / open. - [CLOS] = output 1 active / closed. ▶ Press [Mode/Enter] briefly. > [S.OU2] is displayed. ▶ Press [Set] to set the requested value: <ul style="list-style-type: none"> • If [OU2] = [Hnc], [Hno], [Fnc] or [Fno] (not in 2-wire operation): <ul style="list-style-type: none"> - [OPEN] = output 2 not active / open. - [CLOS] = output 2 active / closed. • If [OU2] = [I] or [InEG]: <ul style="list-style-type: none"> - 3.60...21.10 mA in steps of 0.01 mA. ▶ Press [Mode/Enter] briefly. 	
<p>Process value</p> <p>If [SEL] is active:</p> <ul style="list-style-type: none"> ▶ Press [Set] and keep it pressed until [Proc] is displayed. ▶ Press [Mode/Enter] briefly. > [S.Pr] is displayed. ▶ Press [Set] to set the requested pressure value. ▶ Press [Mode/Enter] briefly. 	

9.6.3 Set time for simulation

<ul style="list-style-type: none"> ▶ Select [S.TIM] and set the value between 1...60 minutes. 	
--	---

9.6.4 Start simulation

<ul style="list-style-type: none">▶ Select [S.ON].▶ Press [Set] and keep it pressed until the display alternately shows [SIM] and the current operation indication. Current operation indication:<ul style="list-style-type: none">- Current system pressure if [SEL] = [OU].- Simulated measured value set in [S.Pr] if [SEL] = [Proc]. <p>After the simulation time has elapsed [S.OFF] is displayed for 2 s, then [SEL].</p>	
<p>Abort simulation:</p> <ul style="list-style-type: none">▶ Press [Mode/Enter] or [Set] briefly. <p>> [S.OFF] is displayed for 2 s, then [SEL].</p>	

10 Operation

After power on, the unit is in the Run mode (= normal operating mode). It carries out its measurement and evaluation functions and provides output signals according to the set parameters.

Operating indicators → Chapter 7 Operating and display elements.

10.1 Read set parameters

- ▶ Press [Mode/Enter] until the requested parameter is displayed.
- ▶ Press [Set] briefly.
- > The unit displays the corresponding parameter value for approx. 15 s. After another 15 s it returns to the Run mode.

10.2 Change the display in the Run mode

- ▶ Press [Set] briefly in the Run mode.
- > The unit indicates the current measured value in the selected type of indication for approx. 15 s:
 - System pressure in the unit set in Uni.
 - System pressure in % of the set scaling of the analogue output if [OU2] is configured as analogue output.
 - System pressure in % of the final value of the measuring range if [OU2] is configured as switching output.

10.3 Self-diagnosis / error indications

The unit has many self-diagnostic options.

- It monitors itself automatically during operation.

- It indicates warnings and faults via IO-Link and via display (even if the display is deactivated).
- If a fault is found, the outputs are set according to the set parameters FOU1 and FOU2 (→ 9.4.2).

Display	IO-Link event number	IO-Link PDValid	IO-Link Device-Status Idx 36	Type of fault	Corrective measures
-/-*	0x5111	no	2**	Supply voltage too low.	<ul style="list-style-type: none"> ▶ Check / correct the supply voltage. ▶ In 2-wire operation: Check / correct the connected load.
SC1	0x8CB3	yes	2**	Excessive current switching output 1.	<ul style="list-style-type: none"> ▶ Check switching output 1 for short-circuit or excessive current; remove the fault.
SC2	0x8CB4	yes	2**	Excessive current switching output 2.	<ul style="list-style-type: none"> ▶ Check switching output 2 for short-circuit or excessive current; remove the fault.
Para	0x1810/ 0x1Fxx	no	2**	Parameter setting fault via IO-Link; setting of one parameter outside the permitted area.	<ul style="list-style-type: none"> ▶ Define the parameters via IO-Link event number 0x1Fxx. ▶ Change parameters via IO-Link or setting buttons. ▶ Reset all parameters to factory setting (→ 9.5.2).
OL	0x8C10	yes	2**	Process value too high.	<ul style="list-style-type: none"> ▶ Check / reduce system pressure.
UL	0x8C30	yes	2**	Process value too low.	<ul style="list-style-type: none"> ▶ Check / increase the system pressure.
E100	0x5000	no	4**	Internal sensor error detected.	<ul style="list-style-type: none"> ▶ Replace the unit.

* In case of undervoltage (fault no. W403) the display shows nothing.

** 2 = Out of Spec / 4 = Failure

Display	IO-Link event number	IO-Link PDValid	IO-Link Device-Status Idx 36	Type of fault	Corrective measures
W531	0x8CA1	yes	2**	Analogue output at the upper limit (20.5 mA).	► Increase AEP value if possible (for [OU2] = [InEG] ASP value) or reduce system pressure.
W530	0x8CA0	yes	2**	Analogue output at the lower limit (3.8 mA).	► Reduce ASP value if possible (for [OU2] = [InEG] AEP value) or increase system pressure.
W532	0x8CA5	yes	2**	Load at analogue output too high.	► Reduce load at output 2 or increase the supply voltage.
W203	0x1822	yes	2**	Error during the temperature compensation of the pressure measurement.	The unit uses a higher temperature coefficient (i.e. with reduced accuracy). ► Replace the unit.
W703	0x8CC2	yes	2**	Medium temperature too high (> 150 °C).	Reduce the medium temperature.
W704	0x8CC3	yes	2**	Medium temperature too low (< -30 °C).	Increase the medium temperature.
W161	0x4210	yes	2**	Unit temperature too high (> 90°C).	Unit outside the specification. ► Do not insulate the installation.
W162	0x4220	yes	2**	Unit temperature too low (< -30 °C).	Unit outside the specification. ► Insulate the installation.

* In case of undervoltage (fault no. W403) the display shows nothing.

** 2 = Out of Spec / 4 = Failure

The fault no. W532 is only displayed for 3-wire operation. For 2-wire operation undervoltage is detected and displayed. If OU2 is not used for the application, the message can be suppressed by defining a switching function for OU2 (→ 9.3.1).

11 Scale drawing

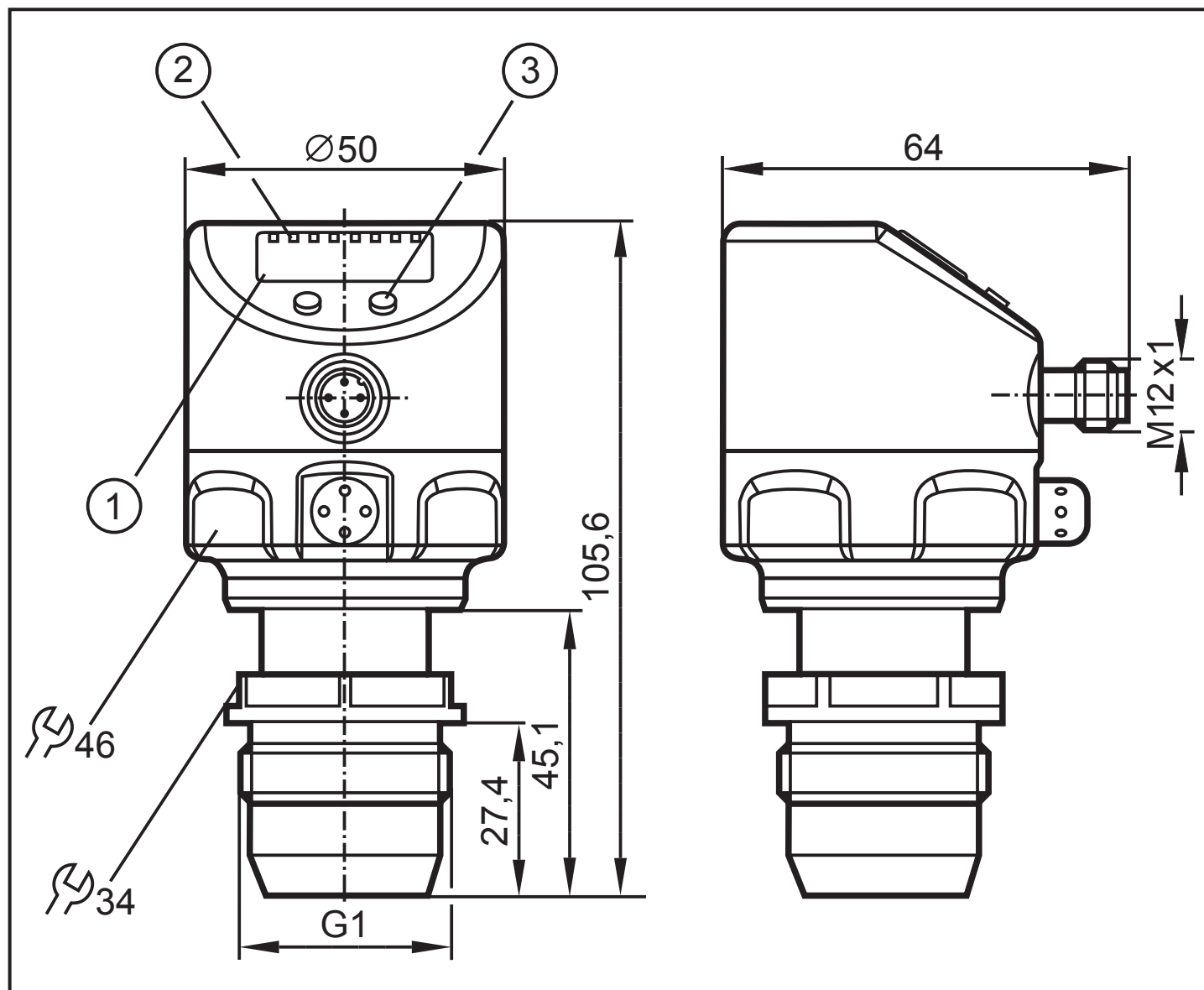

Dimensions in mm

1: Display

2: LEDs

3: Programming button

12 Technical data

	2-wire operation	3-wire operation
Operating voltage [V]	20...32 DC	18...32 DC
Current consumption [mA]	3.6...21	< 45
Current rating [mA]	---	250
Analogue output	4...20 mA / 20...4 mA	
Max. load [Ω]	300	$(U_b - 10) \times 50$
Step response time analogue output [ms]	45	7
Voltage drop [V]	---	< 2
Min. response time switching output [ms]	---	3
Switching frequency [Hz]	---	125
Power-on delay time [s]	1	0.5
Short-circuit protection; reverse polarity protection / overload protection, integrated watchdog		
IO-Link Device Transfer typeCOM2 (38.4 kBaud)		
Accuracy / deviations (in % of the span) ¹⁾		
	PI289x	PI2889
Switch point accuracy [%]	< ± 0.2	< ± 0.5
Characteristics deviation (linearity, incl. hysteresis and repeatability) ²⁾	< ± 0.2	< ± 0.5
Linearity	< ± 0.15	< ± 0.25
Hysteresis	< ± 0.15	< ± 0.2
Repeatability (in case of temperature fluctuations < 10 K)	< ± 0.1	< ± 0.1
Long-term stability (in % of the span per year)	< ± 0.1	< ± 0.1
Temperature coefficients (TC) in the compensated temperature range 0 ...70°C (in % of the span per 10 K)		
	PI289x	PI2889
Greatest TEMPCO of the zero point	< ± 0.05	< ± 0.1
Greatest TEMPCO of the span	< ± 0.15	< ± 0.2

Materials (wetted parts)

.....	stainless steel 316L / 1.4435, surface characteristics: Ra < 0.4 / Rz 4 ceramics (99.9 % Al2O3); PTFE
Housing materials.....	high-grade stainless steel (316L/1.4404); FPM (Viton); PTFE; PBT (Pocan); PEI; PFA
Protection rating	IP 67 / IP 68 / IP 69K
Protection class	III
Insulation resistance [MΩ]	> 100 (500 V DC)
Shock resistance [g]	50 (DIN IEC 68-2-27, 11 ms)
Vibration resistance [g]	20 (DIN IEC 68-2-6, 10 - 2000 Hz)
Switching cycles min.	100 million
Ambient temperature [°C]	-25 ... 80
Medium temperature [°C]	-25... 125 (145 max. 1 h)
Storage temperature [°C]	-40... 100
EMC EN 61000-4-2 ESD:	4 / 8 kV
EN 61000-4-3 HF radiated:	10 V/m
EN 61000-4-4 Burst:	2 kV
EN 61000-4-5 Surge:	0.5 / 1 kV
EN 61000-4-6 HF conducted:	10 V

UK

¹⁾ All indications are referred to a turn-down of 1:1

²⁾ Limit value setting to DIN 16086

12.1 Setting ranges

		SP1 / SP2		rP1 / rP2		ASP		AEP		ΔP
		min	max	min	max	min	max	min	max	
PI2889	mbar	-4.8	100.0	-5.0	99.8	-5.0	75.0	20.0	100.0	0.1
	kPa	-0.48	10.00	-0.50	9.98	-0.50	7.50	2.00	10.00	0.01
	inH ₂ O	-1.92	40.16	-2.00	40.08	-2.00	30.12	8.04	40.16	0.04
	mmWS	-49	1020	-51	1018	-51	765	204	1020	1
PI2893	bar	-0.96	25.00	-1.00	24.96	-1.00	18.74	5.24	25.00	0.02
	PSI	-13.8	362.7	-14.4	362.1	-14.4	271.8	76.2	362.7	0.3
	MPa	-0.096	2.500	-0.100	2.496	-0.100	1.874	0.524	2.500	0.002
PI2894	bar	-0.98	10.00	-1.00	9.98	-1.00	7.50	1.50	10.00	0.01
	PSI	-14.2	145.0	-14.5	144.7	-14.5	108.7	21.8	145.0	0.1
	MPa	-0.098	1.000	-0.100	0.998	-0.100	0.750	0.150	1.000	0.001

ΔP = step increment

		SP1 / SP2		rP1 / rP2		ASP		AEP		ΔP
		min	max	min	max	min	max	min	max	
PI2895	bar	-0.990	4.000	-1.000	3.990	-1.000	3.000	0.000	4.000	0.005
	PSI	-14.35	58.00	-14.50	57.85	-14.50	43.50	0.00	58.00	0.05
	kPa	-99.0	400.0	-100.0	399.0	-100.0	300.0	0.0	400.0	0.5
PI2896	bar	-0.120	2.500	-0.124	2.496	-0.124	1.880	0.500	2.500	0.002
	PSI	-1.74	36.27	-1.80	36.21	-1.80	27.27	7.26	36.27	0.03
	kPa	-12.0	250.0	-12.4	249.6	-12.4	188.0	50.0	250.0	0.2
	inH ₂ O	-48	1004	-50	1002	-50	755	201	1004	1
	mWS	-1.22	25.49	-1.26	25.45	-1.26	19.17	5.10	25.49	0.01
PI2897	mbar	-48	1000	-50	998	-50	750	200	1000	1
	PSI	-0.70	14.50	-0.73	14.47	-0.73	10.88	2.90	14.50	0.01
	kPa	-4.8	100.0	-5.0	99.8	-5.0	75.0	20.0	100.0	0.1
	inH ₂ O	-19.2	401.6	-20.0	400.8	-20.0	301.2	80.4	401.6	0.4
	mWS	-0.49	10.20	-0.51	10.18	-0.51	7.65	2.04	10.20	0.01
PI2898	mbar	-12.0	250.0	-12.4	249.6	-12.4	187.4	50.0	250.0	0.2
	kPa	-1.20	25.00	-1.24	24.96	-1.24	18.74	5.00	25.0	0.02
	inH ₂ O	-4.8	100.4	-5.0	100.2	-5.0	75.2	20.1	100.4	0.1
	mmWS	-122	2550	-126	2546	-126	1912	510	2550	2
PI2899	mbar	-998	1000	-1000	998	-1000	500	-500	1000	1
	PSI	-14.45	14.50	-14.50	14.45	-14.50	7.25	-7.25	14.50	0.05
	kPa	-99.8	100.0	-100.0	99.8	-100.0	50.0	-50.0	100.0	0.1
	inH ₂ O	-400	401	-401	400	-401	201	-201	401	1
	mWS	-10.18	10.20	-10.20	10.18	-10.20	5.10	-5.10	10.20	0.01

ΔP = step increment

More information at www.ifm.com

13 Factory setting

	Factory setting	User setting
SP1	25% VMR *	
rP1	23% VMR *	
OU1	Hno	
OU2	I	
SP2	75% VMR *	
rP2	73% VMR *	
COF / tCOF	0.0	
ASP / tASP	0% VMR * PI2899: -1 bar	
AEP / tAEP	100% VMR *	
Uni	bAr / mbAr	
SELd	P	
dS1	0.0	
dr1	0.0	
dS2	0.0	
dr2	0.0	
FOU1	OUT	
FOU2	OUT	
P-n	pnP	
dAP	0.06	
dAA	0.03	
dis	d2	
CP1	0.00	
CP2	0.00	

* = the indicated percentage of the final value of the measuring range (VMR) of the respective sensor (for PI2899 the percentage of the measuring span) is set.

UK